

74AHC86; 74AHCT86

Quad 2-input EXCLUSIVE-OR gate

Rev. 02 — 15 November 2007

Product data sheet

1. General description

The 74AHC86; 74AHCT86 are high-speed Si-gate CMOS devices and are pin compatible with Low-power Schottky TTL (LSTTL). They are specified in compliance with JEDEC standard no. 7A.

The 74AHC86; 74AHCT86 provides a 2-input exclusive-OR function.

2. Features

- Balanced propagation delays
- All inputs have a Schmitt-trigger action
- Inputs accepts voltages higher than V_{CC}
- For 74AHC86 only: operates with CMOS input levels
- For 74AHCT86 only: operates with TTL input levels
- ESD protection:
 - ◆ HBM JESD22-A114E exceeds 2000 V
 - ◆ MM JESD22-A115-A exceeds 200 V
 - ◆ CDM JESD22-C101C exceeds 1000 V
- Multiple package options
- Specified from -40 °C to $+85\text{ °C}$ and from -40 °C to $+125\text{ °C}$

3. Ordering information

Table 1. Ordering information

| Type number | Package | | | Version |
|-------------------------|-------------------------------------|----------|---|----------|
| | Temperature range | Name | Description | |
| 74AHC86D 74AHCT86D | -40 °C to $+125\text{ °C}$ | SO14 | plastic small outline package; 14 leads; body width 3.9 mm | SOT108-1 |
| 74AHC86PW 74AHCT86PW | -40 °C to $+125\text{ °C}$ | TSSOP14 | plastic thin shrink small outline package; 14 leads; body width 4.4 mm | SOT402-1 |
| 74AHC86BQ 74AHCT86BQ | -40 °C to $+125\text{ °C}$ | DHVQFN14 | plastic dual in-line compatible thermal enhanced very thin quad flat package; no leads; 14 terminals; body $2.5 \times 3 \times 0.85\text{ mm}$ | SOT762-1 |

4. Functional diagram

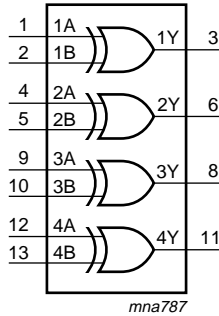

Fig 1. Logic symbol

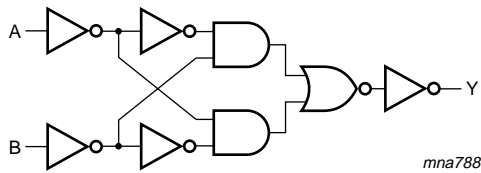

Fig 2. Logic diagram (one gate)

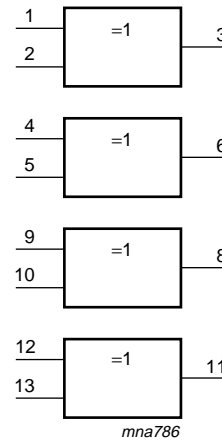
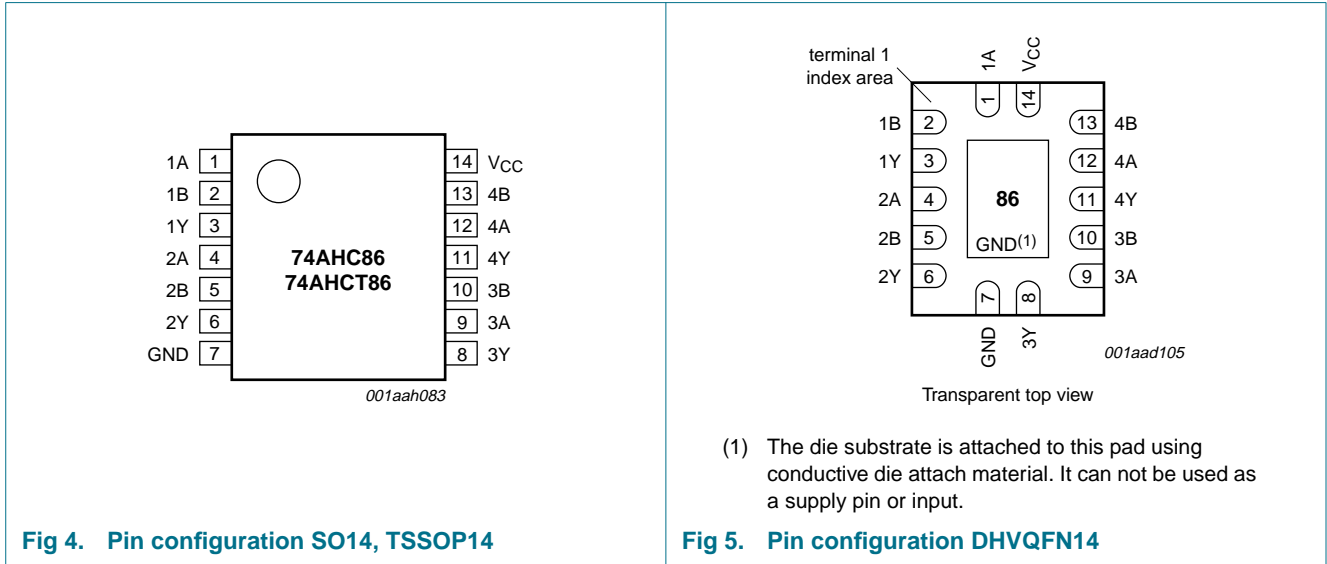

Fig 3. IEC logic symbol

5. Pinning information

5.1 Pinning



5.2 Pin description

Table 2. Pin description

| Symbol | Pin | Description |
|-----------------|--------------|----------------|
| 1A to 4A | 1, 4, 9, 12 | data input |
| 1B to 4B | 2, 5, 10, 13 | data input |
| 1Y to 4Y | 3, 6, 8, 11 | data outputs |
| GND | 7 | ground (0 V) |
| V _{CC} | 14 | supply voltage |

6. Functional description

Table 3. Function table^[1]

| Input nA | Input nB | Output nY |
|----------|----------|-----------|
| L | L | L |
| L | H | H |
| H | L | H |
| H | H | L |

[1] H = HIGH voltage level;
L = LOW voltage level.

7. Limiting values

Table 4. Limiting values

In accordance with the Absolute Maximum Rating System (IEC 60134). Voltages are referenced to GND (ground = 0 V).

| Symbol | Parameter | Conditions | Min | Max | Unit |
|-----------|-------------------------|--|---------|------|------|
| V_{CC} | supply voltage | | -0.5 | +7.0 | V |
| V_I | input voltage | | -0.5 | +7.0 | V |
| I_{IK} | input clamping current | $V_I < -0.5$ V | [1] -20 | - | mA |
| I_{OK} | output clamping current | $V_O < -0.5$ V or $V_O > V_{CC} + 0.5$ V | [1] - | ±20 | mA |
| I_O | output current | $V_O = -0.5$ V to $(V_{CC} + 0.5$ V) | - | ±25 | mA |
| I_{CC} | supply current | | - | 75 | mA |
| I_{GND} | ground current | | -75 | - | mA |
| T_{stg} | storage temperature | | -65 | +150 | °C |
| P_{tot} | total power dissipation | $T_{amb} = -40$ °C to +125 °C | | | |
| | SO14 package | | [2] - | 500 | mW |
| | TSSOP14 package | | [3] - | 500 | mW |
| | DHVQFN14 package | | [4] - | 500 | mW |

[1] The input and output voltage ratings may be exceeded if the input and output current ratings are observed.

[2] P_{tot} derates linearly with 8 mW/K above 70 °C.

[3] P_{tot} derates linearly with 5.5 mW/K above 60 °C.

[4] P_{tot} derates linearly with 4.5 mW/K above 60 °C.

8. Recommended operating conditions

Table 5. Recommended operating conditions

Voltages are referenced to GND (ground = 0 V).

| Symbol | Parameter | Conditions | 74AHC86 | | | 74AHCT86 | | | Unit |
|---------------------|-------------------------------------|--------------------------|---------|-----|----------|----------|-----|----------|------|
| | | | Min | Typ | Max | Min | Typ | Max | |
| V_{CC} | supply voltage | | 2.0 | 5.0 | 5.5 | 4.5 | 5.0 | 5.5 | V |
| V_I | input voltage | | 0 | - | 5.5 | 0 | - | 5.5 | V |
| V_O | output voltage | | 0 | - | V_{CC} | 0 | - | V_{CC} | V |
| T_{amb} | ambient temperature | | -40 | +25 | +125 | -40 | +25 | +125 | °C |
| $\Delta t/\Delta V$ | input transition rise and fall rate | $V_{CC} = 3.3$ V ± 0.3 V | - | - | 100 | - | - | - | ns/V |
| | | $V_{CC} = 5.0$ V ± 0.5 V | - | - | 20 | - | - | 20 | ns/V |

9. Static characteristics

Table 6. Static characteristics

Voltages are referenced to GND (ground = 0 V).

| Symbol | Parameter | Conditions | 25 °C | | | -40 °C to +85 °C | | -40 °C to +125 °C | | Unit |
|---|---------------------------|--|-------|-----|------|------------------|------|-------------------|------|------|
| | | | Min | Typ | Max | Min | Max | Min | Max | |
| For type 74AHC86 | | | | | | | | | | |
| V _{IH} | HIGH-level input voltage | V _{CC} = 2.0 V | 1.5 | - | - | 1.5 | - | 1.5 | - | V |
| | | V _{CC} = 3.0 V | 2.1 | - | - | 2.1 | - | 2.1 | - | V |
| | | V _{CC} = 5.5 V | 3.85 | - | - | 3.85 | - | 3.85 | - | V |
| V _{IL} | LOW-level input voltage | V _{CC} = 2.0 V | - | - | 0.5 | - | 0.5 | - | 0.5 | V |
| | | V _{CC} = 3.0 V | - | - | 0.9 | - | 0.9 | - | 0.9 | V |
| | | V _{CC} = 5.5 V | - | - | 1.65 | - | 1.65 | - | 1.65 | V |
| V _{OH} | HIGH-level output voltage | V _I = V _{IH} or V _{IL} | | | | | | | | |
| | | I _O = -50 μA; V _{CC} = 2.0 V | 1.9 | 2.0 | - | 1.9 | - | 1.9 | - | V |
| | | I _O = -50 μA; V _{CC} = 3.0 V | 2.9 | 3.0 | - | 2.9 | - | 2.9 | - | V |
| | | I _O = -50 μA; V _{CC} = 4.5 V | 4.4 | 4.5 | - | 4.4 | - | 4.4 | - | V |
| | | I _O = -4.0 mA; V _{CC} = 3.0 V | 2.58 | - | - | 2.48 | - | 2.40 | - | V |
| I _O = -8.0 mA; V _{CC} = 4.5 V | 3.94 | - | - | 3.8 | - | 3.70 | - | V | | |
| V _{OL} | LOW-level output voltage | V _I = V _{IH} or V _{IL} | | | | | | | | |
| | | I _O = 50 μA; V _{CC} = 2.0 V | - | 0 | 0.1 | - | 0.1 | - | 0.1 | V |
| | | I _O = 50 μA; V _{CC} = 3.0 V | - | 0 | 0.1 | - | 0.1 | - | 0.1 | V |
| | | I _O = 50 μA; V _{CC} = 4.5 V | - | 0 | 0.1 | - | 0.1 | - | 0.1 | V |
| | | I _O = 4.0 mA; V _{CC} = 3.0 V | - | - | 0.36 | - | 0.44 | - | 0.55 | V |
| I _O = 8.0 mA; V _{CC} = 4.5 V | - | - | 0.36 | - | 0.44 | - | 0.55 | V | | |
| I _I | input leakage current | V _I = 5.5 V or GND; V _{CC} = 0 V to 5.5 V | - | - | 0.1 | - | 1.0 | - | 2.0 | μA |
| I _{CC} | supply current | V _I = V _{CC} or GND; I _O = 0 A; V _{CC} = 5.5 V | - | - | 2.0 | - | 20 | - | 40 | μA |
| C _I | input capacitance | | - | 3.0 | 10 | - | 10 | - | 10 | pF |
| C _O | output capacitance | | - | 4.0 | - | - | - | - | - | pF |
| For type 74AHCT86 | | | | | | | | | | |
| V _{IH} | HIGH-level input voltage | V _{CC} = 4.5 V to 5.5 V | 2.0 | - | - | 2.0 | - | 2.0 | - | V |
| V _{IL} | LOW-level input voltage | V _{CC} = 4.5 V to 5.5 V | - | - | 0.8 | - | 0.8 | - | 0.8 | V |
| V _{OH} | HIGH-level output voltage | V _I = V _{IH} or V _{IL} ; V _{CC} = 4.5 V | | | | | | | | |
| | | I _O = -50 μA | 4.4 | 4.5 | - | 4.4 | - | 4.4 | - | V |
| | | I _O = -8.0 mA | 3.94 | - | - | 3.8 | - | 3.70 | - | V |
| V _{OL} | LOW-level output voltage | V _I = V _{IH} or V _{IL} ; V _{CC} = 4.5 V | | | | | | | | |
| | | I _O = 50 μA | - | 0 | 0.1 | - | 0.1 | - | 0.1 | V |
| | | I _O = 8.0 mA | - | - | 0.36 | - | 0.44 | - | 0.55 | V |

Table 6. Static characteristics ...continued
 Voltages are referenced to GND (ground = 0 V).

| Symbol | Parameter | Conditions | 25 °C | | | –40 °C to +85 °C | | –40 °C to +125 °C | | Unit |
|-----------------|---------------------------|--|-------|-----|------|------------------|-----|-------------------|-----|---------------|
| | | | Min | Typ | Max | Min | Max | Min | Max | |
| I_I | input leakage current | $V_I = 5.5 \text{ V}$ or GND; $V_{CC} = 0 \text{ V}$ to 5.5 V | - | - | 0.1 | - | 1.0 | - | 2.0 | μA |
| I_{CC} | supply current | $V_I = V_{CC}$ or GND; $I_O = 0 \text{ A}$; $V_{CC} = 5.5 \text{ V}$ | - | - | 2.0 | - | 20 | - | 40 | μA |
| ΔI_{CC} | additional supply current | per input pin; $V_I = V_{CC} - 2.1 \text{ V}$; $I_O = 0 \text{ A}$; other pins at V_{CC} or GND; $V_{CC} = 4.5 \text{ V}$ to 5.5 V | - | - | 1.35 | - | 1.5 | - | 1.5 | mA |
| C_I | input capacitance | | - | 3 | 10 | - | 10 | - | 10 | pF |
| C_O | output capacitance | | - | 4.0 | - | - | - | - | - | pF |

10. Dynamic characteristics

Table 7. Dynamic characteristics
 GND = 0 V; For test circuit see [Figure 7](#).

| Symbol | Parameter | Conditions | 25 °C | | | –40 °C to +85 °C | | –40 °C to +125 °C | | Unit |
|-------------------------|-------------------------------|--|------------------|--------------------|------|------------------|------|-------------------|------|-------------|
| | | | Min | Typ ^[1] | Max | Min | Max | Min | Max | |
| For type 74AHC86 | | | | | | | | | | |
| t_{pd} | propagation delay | nA, nB to nY; see Figure 6 ^[2] | | | | | | | | |
| | | $V_{CC} = 3.0 \text{ V}$ to 3.6 V | | | | | | | | |
| | | $C_L = 15 \text{ pF}$ | - | 4.8 | 11.0 | 1.0 | 13.0 | 1.0 | 14.0 | ns |
| | | $C_L = 50 \text{ pF}$ | - | 6.8 | 14.5 | 1.0 | 16.5 | 1.0 | 18.5 | ns |
| | | $V_{CC} = 4.5 \text{ V}$ to 5.5 V | | | | | | | | |
| C_{PD} | power dissipation capacitance | $C_L = 50 \text{ pF}$; $f_i = 1 \text{ MHz}$; $V_I = \text{GND}$ to V_{CC} | ^[3] - | 10.0 | - | - | - | - | - | pF |

Table 7. Dynamic characteristics ...continued
GND = 0 V; For test circuit see Figure 7.

| Symbol | Parameter | Conditions | 25 °C | | | -40 °C to +85 °C | | -40 °C to +125 °C | | Unit |
|--------------------------|-------------------------------|---|-------|--------------------|-----|------------------|------|-------------------|------|------|
| | | | Min | Typ ^[1] | Max | Min | Max | Min | Max | |
| For type 74AHCT86 | | | | | | | | | | |
| t_{pd} | propagation delay | nA, nB to nY; see Figure 6 ^[2] | | | | | | | | |
| | | $V_{CC} = 4.5\text{ V to }5.5\text{ V}$ | | | | | | | | |
| | | $C_L = 15\text{ pF}$ | - | 3.4 | 6.9 | 1.0 | 8.0 | 1.0 | 9.0 | ns |
| | | $C_L = 50\text{ pF}$ | - | 4.9 | 8.8 | 1.0 | 10.0 | 1.0 | 11.0 | ns |
| C_{PD} | power dissipation capacitance | $C_L = 50\text{ pF}; f_i = 1\text{ MHz}; V_i = \text{GND to }V_{CC}$ ^[3] | - | 12.0 | - | - | - | - | - | pF |

- [1] Typical values are measured at nominal supply voltage ($V_{CC} = 3.3\text{ V}$ and $V_{CC} = 5.0\text{ V}$).
- [2] t_{pd} is the same as t_{PLH} and t_{PHL} .
- [3] C_{PD} is used to determine the dynamic power dissipation (P_D in μW).
 $P_D = C_{PD} \times V_{CC}^2 \times f_i \times N + \Sigma(C_L \times V_{CC}^2 \times f_o)$ where:
 f_i = input frequency in MHz, f_o = output frequency in MHz
 C_L = output load capacitance in pF
 V_{CC} = supply voltage in Volts
 N = number of inputs switching
 $\Sigma(C_L \times V_{CC}^2 \times f_o)$ = sum of the outputs.

11. Waveforms

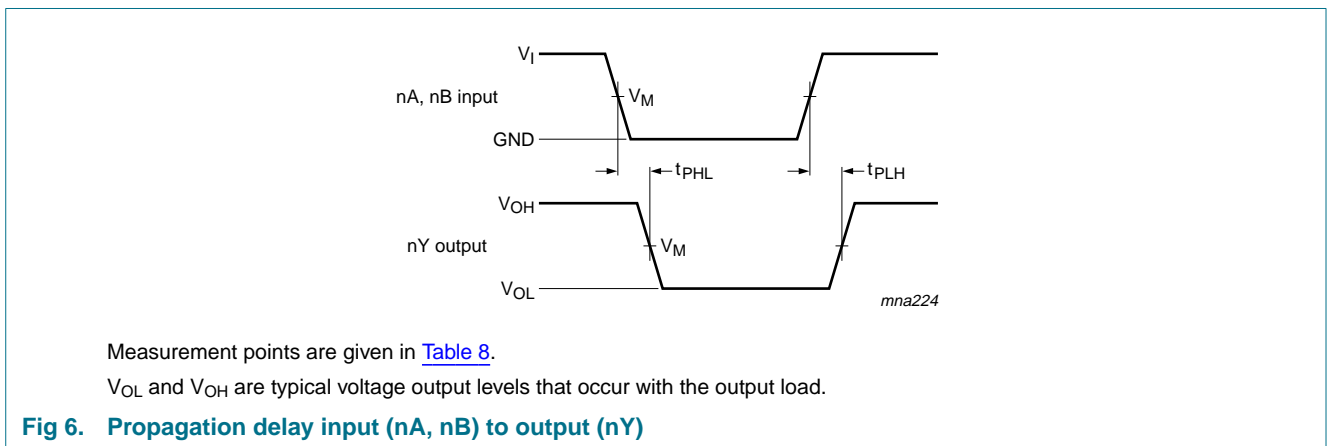
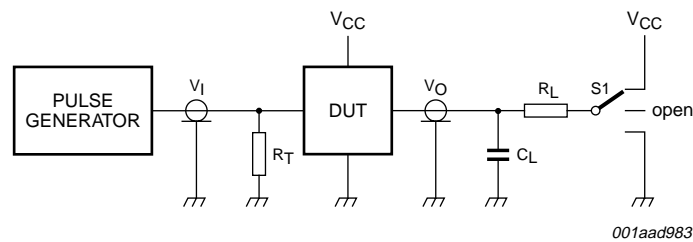
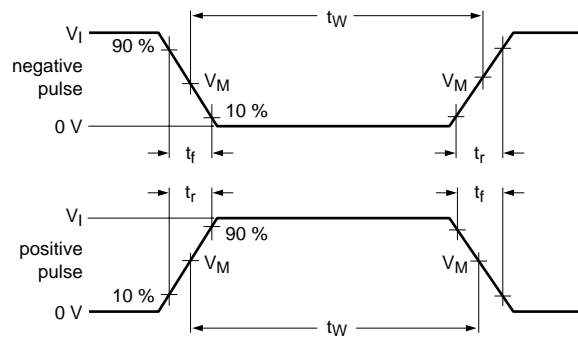

Table 8. Measurement points

| Type | Input | Output |
|----------|-------------|-------------|
| | V_M | V_M |
| 74AHC86 | $0.5V_{CC}$ | $0.5V_{CC}$ |
| 74AHCT86 | 1.5 V | $0.5V_{CC}$ |



001aad983

Test data is given in [Table 9](#).

Definitions test circuit:

R_T = Termination resistance should be equal to output impedance Z_o of the pulse generator

C_L = Load capacitance including jig and probe capacitance

R_L = Load resistor

S1 = Test selection switch

Fig 7. Load circuitry for switching times

Table 9. Test data

| Type | Input | | Load | | S1 position | | |
|----------|----------|------------|--------------|--------------|--------------------|--------------------|--------------------|
| | V_I | t_r, t_f | C_L | R_L | t_{PHL}, t_{PLH} | t_{PZH}, t_{PHZ} | t_{PZL}, t_{PLZ} |
| 74AHC86 | V_{CC} | 3.0 ns | 15 pF, 50 pF | 1 k Ω | open | GND | V_{CC} |
| 74AHCT86 | 3.0 V | 3.0 ns | 15 pF, 50 pF | 1 k Ω | open | GND | V_{CC} |

12. Package outline

SO14: plastic small outline package; 14 leads; body width 3.9 mm

SOT108-1

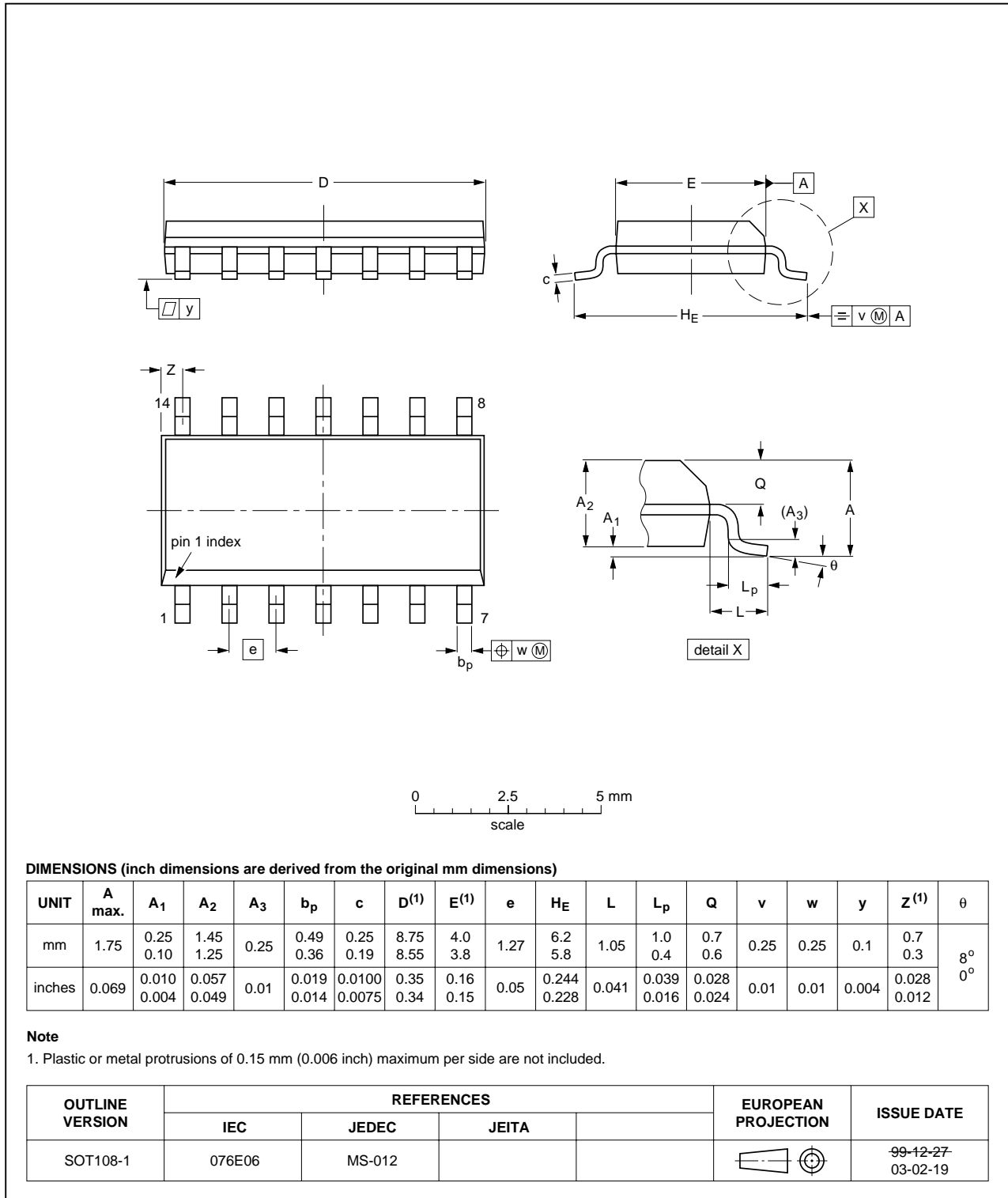

Fig 8. Package outline SOT108-1 (SO14)

TSSOP14: plastic thin shrink small outline package; 14 leads; body width 4.4 mm

SOT402-1

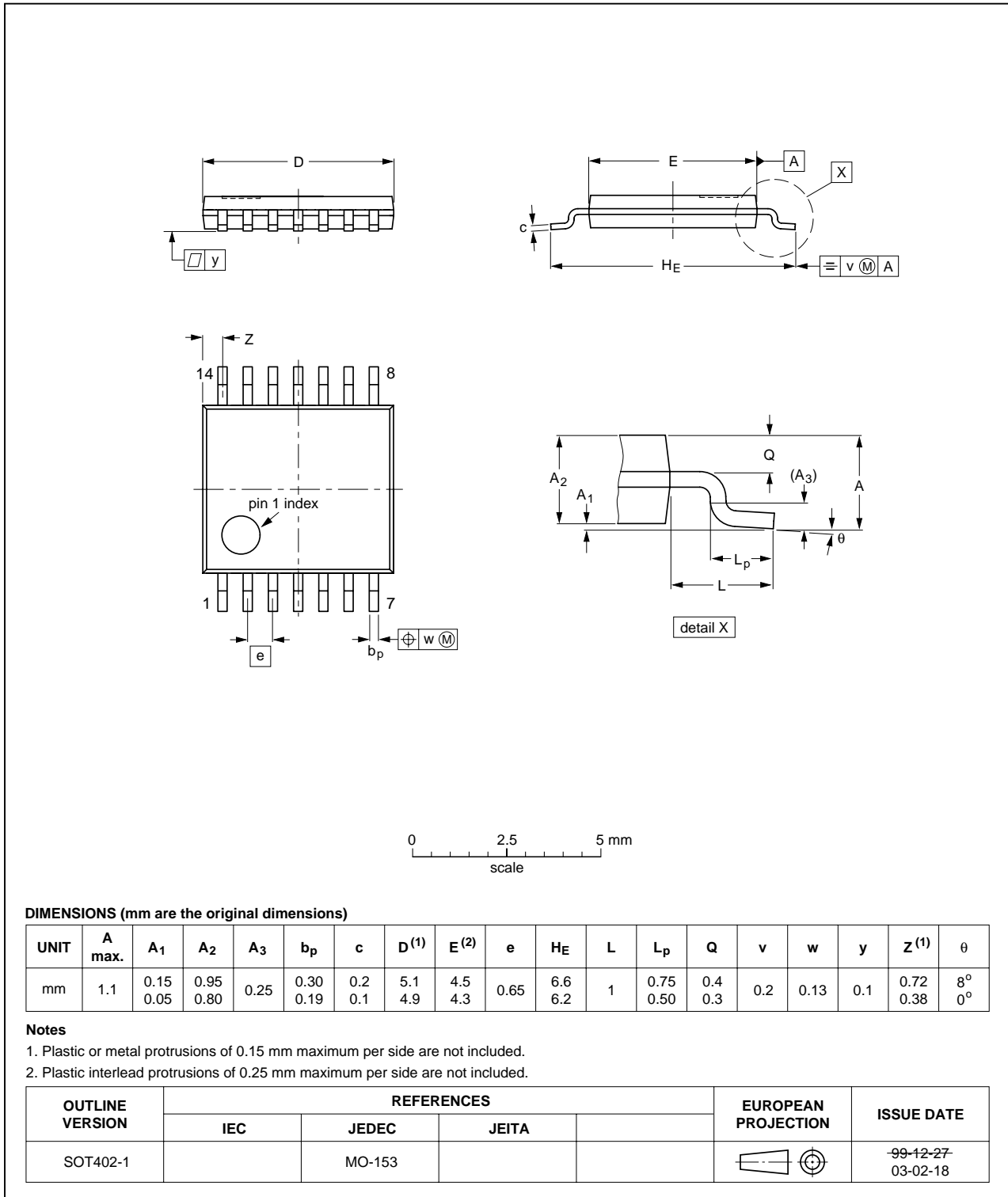

Fig 9. Package outline SOT402-1 (TSSOP14)

DHVQFN14: plastic dual in-line compatible thermal enhanced very thin quad flat package; no leads; 14 terminals; body 2.5 x 3 x 0.85 mm

SOT762-1

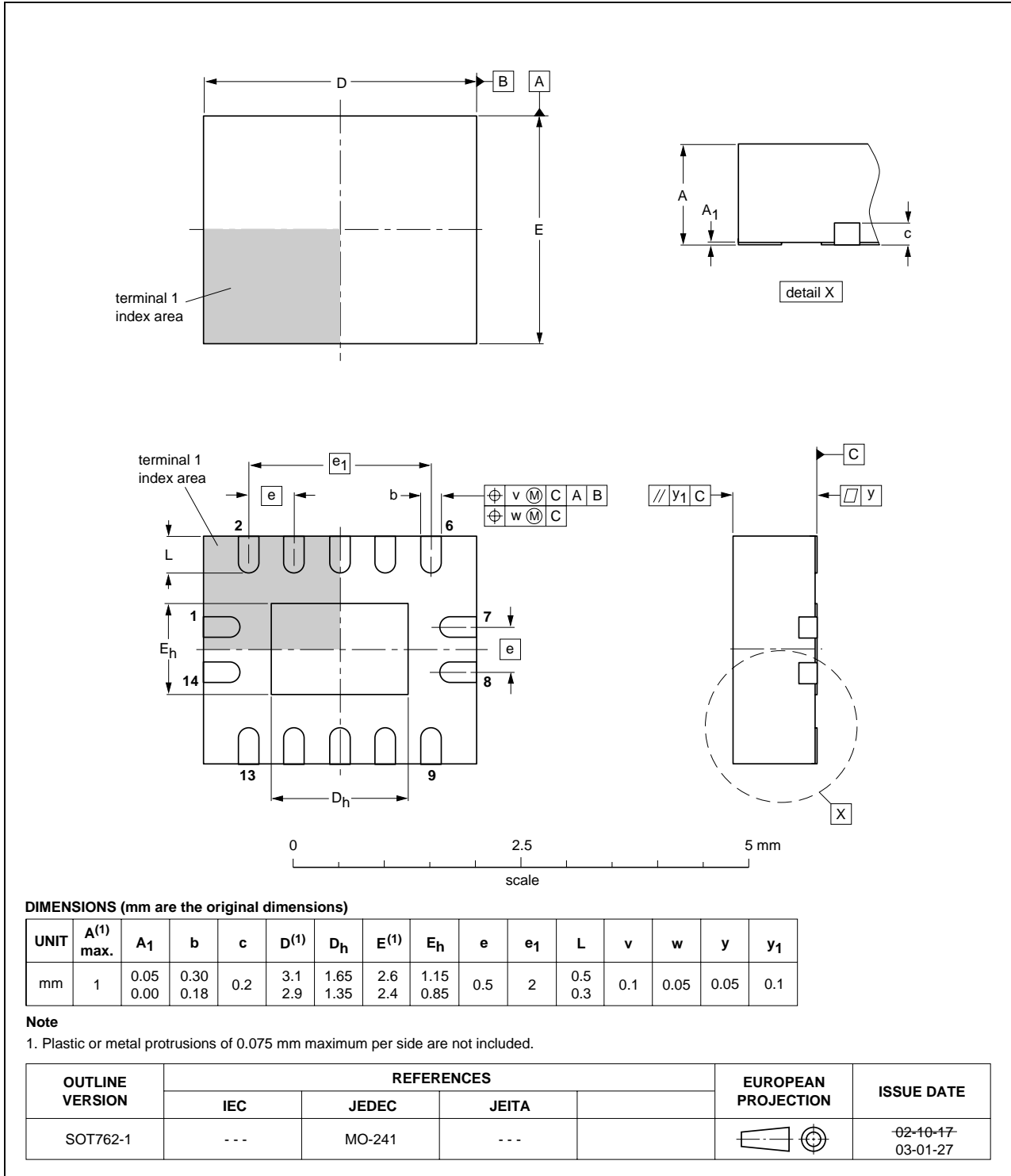

Fig 10. Package outline SOT762-1 (DHVQFN14)

13. Abbreviations

Table 10. Abbreviations

| Acronym | Description |
|---------|---|
| CDM | Charged Device Model |
| CMOS | Complementary Metal Oxide Semiconductor |
| DUT | Device Under Test |
| ESD | ElectroStatic Discharge |
| HBM | Human Body Model |
| MM | Machine Model |
| TTL | Transistor-Transistor Logic |

14. Revision history

Table 11. Revision history

| Document ID | Release date | Data sheet status | Change notice | Supersedes |
|----------------|--|-----------------------|---------------|----------------|
| 74AHC_AHCT86_2 | 20071115 | Product data sheet | - | 74AHC_AHCT86_1 |
| Modifications: | <ul style="list-style-type: none"> • The format of this data sheet has been redesigned to comply with the new identity guidelines of NXP Semiconductors. • Legal texts have been adapted to the new company name where appropriate. • Section 3: DHVQFN14 package added. • Section 7: derating values added for DHVQFN14 package. • Section 12: outline drawing added for DHVQFN14 package. | | | |
| 74AHC_AHCT86_1 | 19990917 | Product specification | - | - |

15. Legal information

15.1 Data sheet status

| Document status ^{[1][2]} | Product status ^[3] | Definition |
|-----------------------------------|-------------------------------|---|
| Objective [short] data sheet | Development | This document contains data from the objective specification for product development. |
| Preliminary [short] data sheet | Qualification | This document contains data from the preliminary specification. |
| Product [short] data sheet | Production | This document contains the product specification. |

[1] Please consult the most recently issued document before initiating or completing a design.

[2] The term 'short data sheet' is explained in section "Definitions".

[3] The product status of device(s) described in this document may have changed since this document was published and may differ in case of multiple devices. The latest product status information is available on the Internet at URL <http://www.nexperia.com>.

15.2 Definitions

Draft — The document is a draft version only. The content is still under internal review and subject to formal approval, which may result in modifications or additions. Nexperia does not give any representations or warranties as to the accuracy or completeness of information included herein and shall have no liability for the consequences of use of such information.

Short data sheet — A short data sheet is an extract from a full data sheet with the same product type number(s) and title. A short data sheet is intended for quick reference only and should not be relied upon to contain detailed and full information. For detailed and full information see the relevant full data sheet, which is available on request via the local Nexperia sales office. In case of any inconsistency or conflict with the short data sheet, the full data sheet shall prevail.

15.3 Disclaimers

General — Information in this document is believed to be accurate and reliable. However, Nexperia does not give any representations or warranties, expressed or implied, as to the accuracy or completeness of such information and shall have no liability for the consequences of use of such information.

Right to make changes — Nexperia reserves the right to make changes to information published in this document, including without limitation specifications and product descriptions, at any time and without notice. This document supersedes and replaces all information supplied prior to the publication hereof.

Suitability for use — Nexperia products are not designed, authorized or warranted to be suitable for use in medical, military, aircraft, space or life support equipment, nor in applications where failure or

malfunction of a Nexperia product can reasonably be expected to result in personal injury, death or severe property or environmental damage. Nexperia accepts no liability for inclusion and/or use of Nexperia products in such equipment or applications and therefore such inclusion and/or use is at the customer's own risk.

Applications — Applications that are described herein for any of these products are for illustrative purposes only. Nexperia makes no representation or warranty that such applications will be suitable for the specified use without further testing or modification.

Limiting values — Stress above one or more limiting values (as defined in the Absolute Maximum Ratings System of IEC 60134) may cause permanent damage to the device. Limiting values are stress ratings only and operation of the device at these or any other conditions above those given in the Characteristics sections of this document is not implied. Exposure to limiting values for extended periods may affect device reliability.

Terms and conditions of sale — Nexperia products are sold subject to the general terms and conditions of commercial sale, as published at <http://www.nexperia.com/profile/terms>, including those pertaining to warranty, intellectual property rights infringement and limitation of liability, unless explicitly otherwise agreed to in writing by Nexperia. In case of any inconsistency or conflict between information in this document and such terms and conditions, the latter will prevail.

No offer to sell or license — Nothing in this document may be interpreted or construed as an offer to sell products that is open for acceptance or the grant, conveyance or implication of any license under any copyrights, patents or other industrial or intellectual property rights.

15.4 Trademarks

Notice: All referenced brands, product names, service names and trademarks are the property of their respective owners.

16. Contact information

For additional information, please visit: <http://www.nexperia.com>

For sales office addresses, send an email to: salesaddresses@nexperia.com

17. Contents

| | | |
|-----------|---|-----------|
| 1 | General description | 1 |
| 2 | Features | 1 |
| 3 | Ordering information | 1 |
| 4 | Functional diagram | 2 |
| 5 | Pinning information | 3 |
| 5.1 | Pinning | 3 |
| 5.2 | Pin description | 3 |
| 6 | Functional description | 3 |
| 7 | Limiting values | 4 |
| 8 | Recommended operating conditions | 4 |
| 9 | Static characteristics | 5 |
| 10 | Dynamic characteristics | 6 |
| 11 | Waveforms | 7 |
| 12 | Package outline | 9 |
| 13 | Abbreviations | 12 |
| 14 | Revision history | 12 |
| 15 | Legal information | 13 |
| 15.1 | Data sheet status | 13 |
| 15.2 | Definitions | 13 |
| 15.3 | Disclaimers | 13 |
| 15.4 | Trademarks | 13 |
| 16 | Contact information | 13 |
| 17 | Contents | 14 |